

Thermodynamic Process Modeling in Pressure Wave Superchargers

Iuliana Costiuc and Anghel Chiru

Transilvania University of Brasov, Romania

{costiuciuliana,achiru}@unitbv.ro

Abstract. The Pressure Wave technology has proved real potential in improving performance and efficiency of thermodynamic systems. Its working principle is based on the transfer of energy between two fluids that are in direct contact for a very short period of time. This technology was implemented in many various applications, including: pressure wave superchargers for internal combustion engines, wave rotor constant volume combustors, novel generation of rotary thermal separators, wave rotor refrigerators, ultra-micro gas turbines, heat exchangers cleaning devices, etc.

This paper is a theoretical analysis of the evolution of the pressures along the wave rotor channels for the exhaust gases and for the fresh air. Furthermore, a simulation of the phenomenon at the contact of the two fluids is provided in order to show the interaction of the high energy fluid with the low energy fluid.

The theoretical analysis was made using COMSOL Multiphysics software. The study results were represented graphically.

The simulation was modeled to reproduce data such as pressures, mass flows and velocities usually measured in real engine pressure wave supercharging. Results were obtained at different range of operating time aiming a high boost pressure into the intake manifold that can assure a better response in increasing the engine power.

Keywords: Wave rotors; pressure wave supercharging; internal combustion engines; shock waves; rotor channels.

1 Introduction

A key priority for the European Union and other nations is preventing the climate change by reducing substantially the greenhouse gas emissions, the main cause of the increase in global temperature [1]. One EU key target for 2020 is cutting 20% in greenhouse gas emissions compared with 1990, as well as 40% cut for 2030 [1]. The long-term consequences of the climate change have led to legislative measures meant to reduce the high levels of pollution, mainly caused by its primary factor: burning fossil fuels.

As the propulsion systems are the main consumers of fossil fuels, it is stated that the road transport sector is responsible for about a fifth of greenhouse gas emissions in Europe [2]. Therefore, the internal combustion engines (ICE) became the primary object for energy conservation and emission reduction in the world [3 in 4]. Under the circumstances, higher energy utilization efficiency and lower emissions are the two major development momentums for IC engine [4].

An optimized thermal management of the ICE and new design of its auxiliary elements can make possible the achievement of the major goals outlined above, by improving the energy utilization efficiency and overall performance, by waste heat recovery, by lowering the fuel consumption, thus lowering the gas emissions.

Since the higher IC engine thermal efficiency appears in the higher load area, boosting pressure becomes one of the effective methods to improve IC engine thermal efficiency [4]. The most important parameters of the power production are: the engines' rotational speed, the engine displacement and the intake manifold pressure [5].

The designers can intervene into modifying the engine displacement or the intake pressure, since the speed in function of the operation needs. The displacement cannot be increased without increasing the friction losses, resulting thus a lowering in the engine's efficiency. Therefore, the most convenient way to increase the power production is to raise the intake manifold pressure, concept generally known as supercharging. It is realized through the use of superchargers or turbochargers.

Superchargers and turbochargers are compressors positioned on the admission part of the engine in order to rise the pressure of the incoming air. By using the mechanical supercharging, the improvement to ICE thermal efficiency is very limited because part of ICE effective work is consumed to drive the compressor [4]. Another conventional approach of boosting pressure is exhaust turbocharging, which uses IC engine exhaust gas energy to drive the compressor through exhaust turbocharger. Turbochargers are the most commonly used solutions for car manufacturers to produce useful boost as they have more advantages, e.g., higher thermal efficiency, for the compressor power comes from exhaust gas energy rather than IC engine effective work. However, studies indicate that turbocharging has also some disadvantages [6 in 4] and one of the obvious defects is that it leads to a higher exhaust gas pressure [4].

Many other alternatives succeed to overcome the shortcomings of engine turbocharging; among them, the pressure wave supercharger (PWS) is a promising solution. Pressure wave devices (known as wave rotors) use shockwaves to transfer energy directly between fluids without additional mechanical components, thus having the potential for increased efficiency [7]. In a PWS the interaction between the exhaust high pressure and high temperature gas and the low pressure and low temperature air produce boost. In short terms, the hot gases produce a shock wave that expands through the channels and compresses the fresh air. The rapid response on the engine torque for the entire range of engine speed and the inlet air pulse pressure are reasons for considering the PWS a good option of supercharging the ICE for road vehicles.

The interest on the subject of pressure wave technology present a steady but slow progress. However, since the first real application made by Claude Seippel in 1940, wave rotors have been a research goal for decades [8]. Most of the researches were experimental since the theoretical determinations of the complex phenomena occur-

ring inside a pressure wave device were rather difficult without well-developed computational instruments. Recently, new computer software dedicated to accurate simulation of the processes inside the wave rotor devices, together with modern experimental measurements and diagnostic techniques have renewed interest in this technology [8].

2 PW Supercharging

Theory of Operation

Basically, the PWS is placed in parallel with the ICE within the thermodynamic cycle. PWSs' principle of operation is based on the fact that if two fluids having different pressures are brought into direct contact in long narrow channels, equalization of pressure occurs faster than mixing [9].

The channels are shaped longitudinally into a rotor, called "cell wheel" that rotates between two fixed casings (end plates). The fluids entering the PWS are the high-pressure exhaust gases (HPG) coming from the ICE and the low-pressure air (LPA). As the thermodynamic and pulsatory phenomena occur inside the channels, the resulting fluids leaving the PWS are low pressure gases (LPG) that suffered an extension process into the channels and the compressed air (HPA) leaving the PWS at a higher pressure.

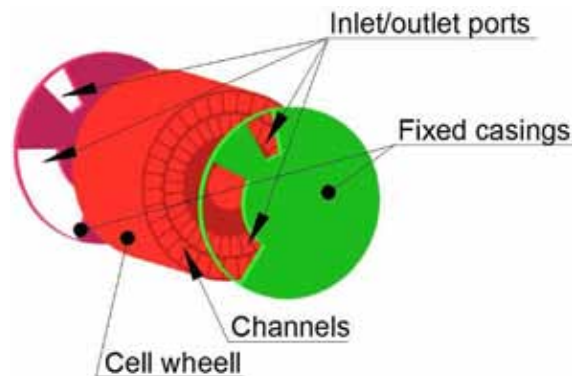

Fig. 1. Main components of a pressure wave supercharger

The cell wheel is driven by a separate motor or a belt driven by the crankshaft. The fixed end plates contain passages through which enter the low pressure air and the high pressure gases or exit the high pressure air and the low pressure gases. The ports are connected to the inlet system and the exhaust system, respectively. The exhaust gas inlet port is designed small enough to cause a significant pressure rise in the exhaust manifold [9].

The pressure wave process does not depend on the pressure and flow fluctuations inside the manifold caused by individual cylinder exhaust events; its operation can be explained assuming constant pressure at each set of ports [9].

In Figure 2 is shown the interaction between the components of a four port PWS. The form, dimensions, number and position of ports vary for different applications [10]. Since the end plates that include the ports have fixed positions, the channel ends of the rotor are exposed alternatively to the ports, allowing the fluids flow through the passages. Thus, the compression and expansion waves are initiated within the PWS channels; the entering gas generates shock waves that evolve along the channel and compress the fresh air.

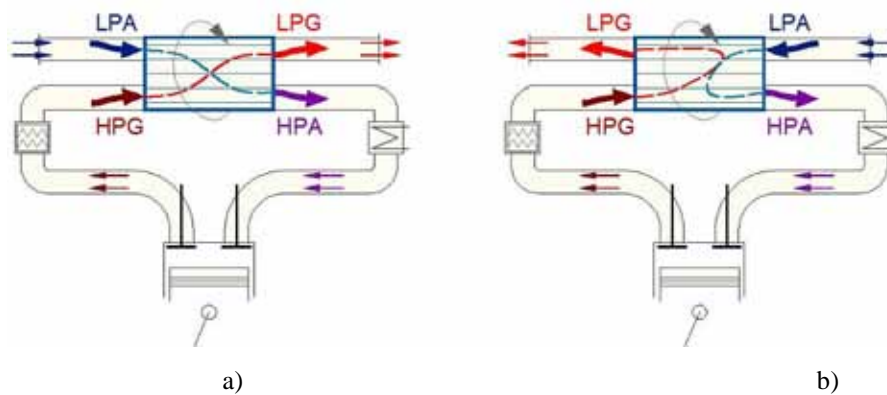

Fig. 2. PWS configurations

PWS can be designed for different fluid passage in two configurations, as shown in Fig. 2:

- a) passing-through flow - when all flows travel in the same direction and
- b) reverse flow - when each flow (gas or air) exits on the same side [7] (inlet and outlet ports are placed on the same end plate). The analysis in this paper is made on a PWS with reverse flow.

The processes inside the narrow channels can be explained using simplified models, presented in the field literature. Basically, the high pressure and high temperature gases exiting from the engine's combustion chamber (HPG) come into contact with the low pressure air (LPA) and a shock wave is formed that starts the compression process. The high pressured air (HPA) leaves PWS towards the inlet manifold while the lowered pressure gases (LPG) are scavenged into the exhaust system.

This paper presents a theoretical analysis of the evolution of the pressures along the channels of a PWS for the exhaust gases and for the fresh air. Furthermore, a simulation of the phenomenon at the contact of the two fluids is provided in order to show the interaction of the high energy fluid with the low energy fluid.

3 Numerical Model

In the past years several researchers have investigated compressible flow in PWS channels. Some have been focused on 2D characteristics of the compressible flow [7], other studied the unsteady flow processes in wave rotors [8]. The numerical models used are considered as two-dimensional numerical approaches to save computational time.

In the present work a numerical model was created a three-dimensional numerical model. It was designed to simulate as best as possible conditions in a PWS channels. The 3D-PWS channels are modeled using basic dimensions for CX-93 pressure wave rotor. A gap between exhaust gas plate and air plate with rotor was considered having 1 mm thickness. The rotor was at this step of modeling considered constructed with 2 layers of channels. Air and gases inlets and outlets covers only one layer of channels.

The geometry was created in 3D using CAD software, and was imported in Comsol. In Fig. 3 is presented only air domain of the geometry. The mesh resulted after some geometry repair operations using internal meshing module is presented in Fig.4 consisting in 283682 tetrahedral elements.

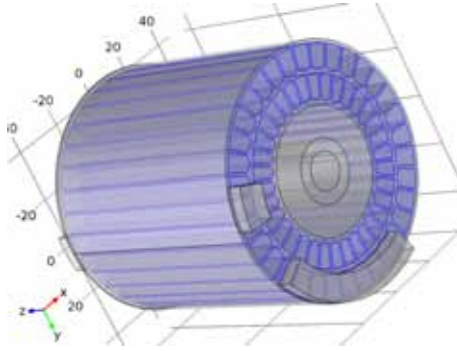

Fig. 3. PWS geometry

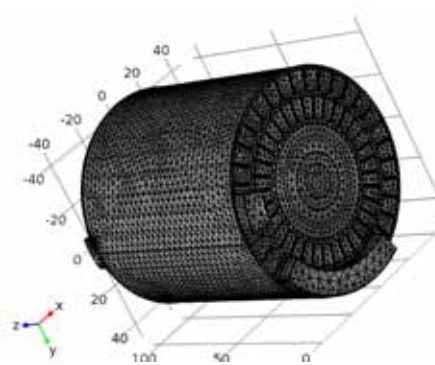

Fig. 4. PWS mesh

The rotor material used in modeling was considered steel and the fluid used was air. Air was considered as compressible gas. The specific heat, thermal conductivity and the viscosity were considered as temperature dependent.

An implicit solver model of Comsol was used, coupling the conservation and momentum equations with the energy equation and the flow was treated as turbulent and time dependent. To simulate the PWS behavior a rotating machinery model was used.

Boundary conditions at inlet and outlet ports were set up as: a pressure inlet on the right side of the inlet gases duct, and a pressure inlet at the left side for fresh air inlet duct. The PWS channels and the ports were initially assumed to be filled with fluid (air) at a reference constant pressure and temperature. A high pressure, high temperature fluid was supplied to the gases inlet duct. To the entire rotating domain containing fluid an axial motion was set up with the rotational speed n . The boundary conditions are presented in Table 1.

Table 1. Entry data for the analytical model

Property	Value
Static gases inlet pressure (p_{gi})	$3.00 \cdot 10^5$ Pa
Static air inlet pressure (p_{ai})	$0.98 \cdot 10^5$ Pa
Inlet gases velocity (u_{gi})	250 m/s
Air specific gas constant (R_{air})	287 J/kg K
Channel length (L)	10^{-2} m
Rotational speed (n_1)	185 s^{-1}

4 Results

The results obtained with the CFD model described above are presented below. The pressure distribution in PWS channels in contour plot is presented in Fig. 5. The velocity field is presented in Fig. 6. The pressure distribution in function of time for a single PWS channel in the case of flow that is moving from right to left is presented in Fig. 7.

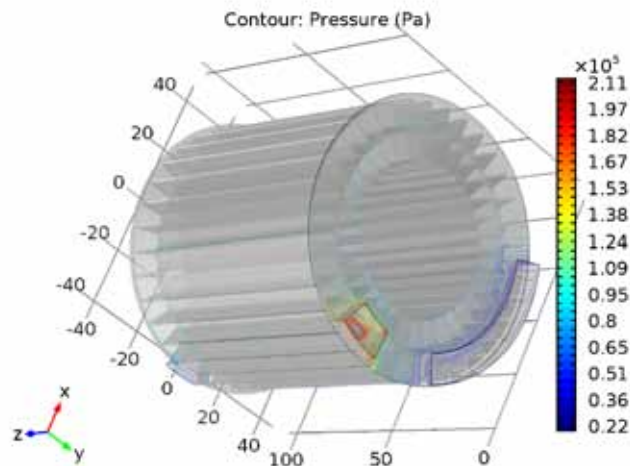
**Fig. 5.** Pressure contour plot from gas side view

In the Fig. 5 the pressure plot was obtained for converged stationary regime using boundary conditions for pressure and velocity.

The velocity field in Fig. 6 was plot in downscale to show the velocities in entire air domain.

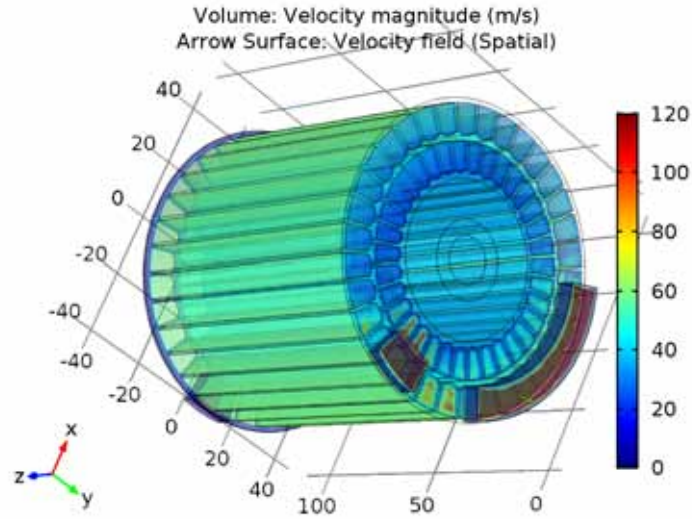

Fig. 6. Velocity field plot from gas side view.

In the time dependent study the time step in seconds was taken as $0.1 \cdot 10^{-3}$ s from 0 to $1 \cdot 10^{-3}$ s in order to represent the evolution of the pressure wave along the PWS channel. The pressure evolution in function of time for a single PWS channel (Fig. 7) shows that the pressure wave reaches a maximum value of $1.38 \cdot 10^5$ Pa at $0.4 \cdot 10^{-3}$ s.

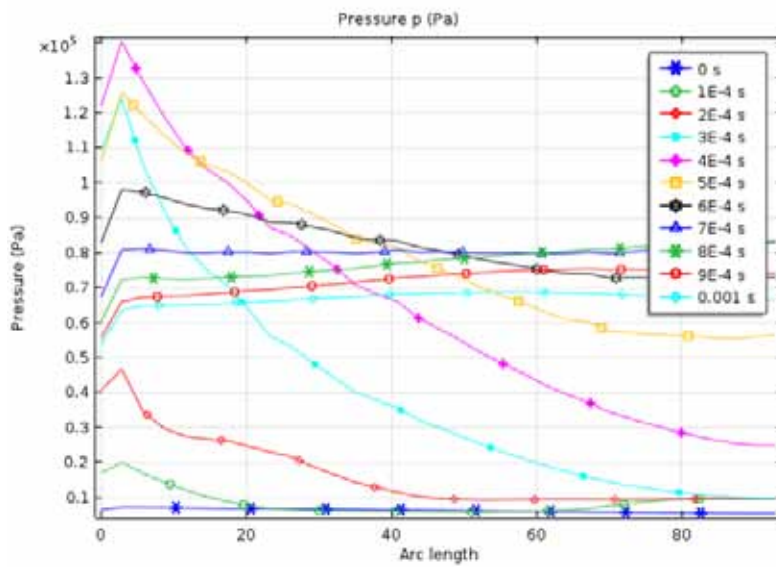

Fig. 7. Pressure plot along a single channel in function of operating time

5 Conclusions

The 3D model was developed to investigate the PWS dynamics in order to generate an instrument to improve the engine performance. Using improved 3D CFD numerical methods appears to be a promising solution. The pressure and velocity profile inside the PWS channels were obtained and graphically represented. Also a time dependent study was performed and the pressure wave profile along PWS channel was presented.

All theoretical and numerical results presented were made in order to set-up a 3D numerical model to improve the PWS efficiency. The experimental results from existing literature and the future experimental data will be used for further validation of the presented 3D model. In the next steps research will be extended in stationary and dynamic regimes to reveal the influence of various state, functional and geometrical parameters on the dynamic phenomena of pressures, air velocities, exhaust gases and on the PWS pockets and channels.

References

1. http://ec.europa.eu/clima/citizens/eu/index_ro.htm - European Comision - Climate Action
2. <http://www.eea.europa.eu/> EEA, 2015b, Monitoring CO2 emissions from new passenger cars and vans in 2014. EEA Technical report No 16/2015, European Environment Agency.
3. Fu, JQ, Liu, JP, Xu, ZX, Ren, CQ, Deng, BL.: A combined thermodynamic cycle based on methanol dissociation for IC (internal combustion) engine exhaust heat recovery. *Energy* 55:778–86 (2013)
4. Fu, J, Liu, J., Wang, Y., Deng, B., Yang, Y., Feng, R., Yang, J.: A comparative study on various turbocharging approaches based on IC engine exhaust gas energy recovery, *Applied Energy* 113 (2014) 248–257
5. Spring, P.: Modeling and Control of Pressure-Wave Supercharged Engine Systems, Diss. ETH No. 16490, Swiss Federal Institute of Technology, ETH Zurich (2006)
6. Liu, JP, Fu, JQ, Ren, CQ, Wang, LJ, Xu, ZX, Deng, BL: Comparison and analysis of engine exhaust gas energy recovery potential through various bottom cycles. *Appl Therm Eng*;50:1219–34 (2013)
7. Iancu, F., Piechna, J., Müller, N., Basic design scheme for wave rotors, *Shock Waves* (2008) 18:365–378, DOI 10.1007/s00193-008-0165-7, Springer Verlag (2008)
8. Frackowiak, M., Iancu, F., Potrzebowski, A., Ackbari, P., Müller, N., Piechna, J.: Numerical Simulation of Unsteady - Flow Processes in Wave Rotors, Proceedings of IMECE04 2004 ASME International Mechanical Engineering Congress, Anaheim, California USA, November 13–19 (2004)
9. Heywood, J.: *Internal Combustion Engine Fundamentals*, McGraw-Hill International Editions, I. Title, II. Series (1988).