

DEFLECTION AND PRECAMBERING OF STEEL BEAMS

R. BĂNCILĂ¹ D. BOLDUŞ¹ A. FEIER² S. HERNEA¹
M. MALIŢA¹

Summary: Steel beams are used in the construction of industrial, commercial buildings, bridges and other structures. Deflection in a steel beam describes the amount of deformation the beam will incur under load. Precambering reduce the deflection under load being one of the requirements of deflection checking. The present paper describes the calculus of the deflection and the necessity of precambering in different structural elements.

Key words: Deflection, Precambering, Plate girders, Truss girders.

1. Introduction

Serviceability Limit State (SLS) is the design state such, that the structure remains functional for its intended use, subject to the different everyday loadings. SLS is the point where a structure can no longer be used for it's intended purpose, but would still be structurally robust (for example a beam deflect by more than the SLS limit, will not necessarily fail structurally). The occupants may feel uncomfortable, if there are unacceptable deformations, drifts or vibrations. In the case of SLS, the judgements are usual non-technical, involving perceptions and expectations

of building owners and occupants. Sometimes it is part of the contractual agreement with the owner, than life-safety related.

It is important to mention that, serviceability problems cost more money to correct than would be spent preventing the problem in the design phase [1].

Generally, the serviceability limit state includes [2] the verification of:

the functioning of the structure or structural members under normal use (including the adjacent machines or services)

the comfort of the people

the appearance of the construction works

¹ Universitatea Politehnica Timisoara, Facultatea de Constructii

² Urban INCERC-Sucursala Timisoara

It is mention that appearance refers to deflection and extensive cracking, rather than aesthetics.

Serviceability requirements are established for each structure.

Generally it shall be verified that:

$$Ed \leq Cd \quad (1)$$

where

Ed – is the design value of the effects of actions specified in the serviceability criterion determined on the base of the relevant combination.

Cd – limiting value for the relevant serviceability criterion.

For buildings structures the simplified combinations of actions are the followings:

considering only the most unfavorable variable action:

$$\sum_j G_{k,j} + Q_{k,1} \quad (2)$$

considering all unfavorable actions:

$$\sum_j G_{k,j} + 0,9 \sum_{i>1} Q_{k,i} \quad (3)$$

It must be underlined that, γ_M for the SLS verification shall be taken as 1,0 (characteristic values of the loads). The limiting values for vertical deflections are presented in Figure 1.

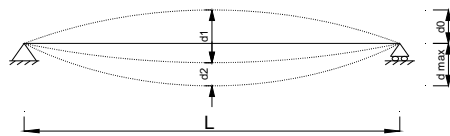

Fig. 1. Vertical deflections of a simple supported beam

$$\delta_{\max} = \delta_1 + \delta_2 - \delta_0 \quad (4)$$

where:

δ_{\max} – is the maximum deflection (sagging) in the final state, relative to the straight line joining the supports;

δ_0 – is the precamber of the beam in the unloaded (state 0)

δ_1 – is the variation of the deflection of the beam due to the permanent loads, immediately after loading (state 1)

δ_2 – is the variation of the deflection of the beam due to the variable loads, increased with the deflection of the beam due to the permanent loads (state 2).

The recommended limits for vertical deflection are given in the Eurocodes standards for different structures and are generally between $L/150 - L/1000$, where L is the span of the beam.

Excessive deflections can produce distortion in connections and lead to high secondary stresses.

They are indicators of the lack of rigidity which might result in vibration and overstress under dynamic load and discomfort for the human uses of the structure. For the usual structures some values for the ratio maximum deflection/span (f/L) according to [3], are presented:

roofs and purlins $L/200 - L/250$

Large deflections have as result a poor drainage of the roof and the increasing of the loads due to “ponding”.

floors ceilings $L/250 - L/300$

floors supporting other structures
 $L/500$

Excessive deflections may produce cracks in ceilings, floors or partition.

highway bridge main girders and cross girders $L/500$

railway bridge main girders and cross girders $L/800$

crane girders, light use $L/500$

crane girders, heavy use (service class) $L/800 - L/1000$

Where the appearance of the structure can be affected, a maximum deflection of $L/250$ is recommended. For crane girders the limitation of the deflection avoids the “up and down” rolling, respectively the inclination of the crane. [4]

The deformations of crane girders are calculated without the dynamic coefficient [5].

A special attention must be paid for bridges. By railway bridges the limitation of the deformations avoids the derailment (especially by high speed), respectively the increasing of the dynamic effect (the trajectory is curved – centrifugal force). In the case of underpasses the limitation of the structure deformation assures the clearance gauge.

For bridges the European Standard SREN 1990:2004/A1:2006 [6], prescribes:

for highway bridges the SLS verification is needed only in special cases. The frequent loading combination is recommended (p. A.2.4.2.)

for railway bridges, the maximum deflection is $L/600$ (p. A.2.4.4.2.3.).

For bridges the dynamic coefficient Φ are taken in consideration (UIC, SW0 and SW2 convoys).

The German Standard for railway bridges [7], are more severe and conservative, especially for high speeds.

Speed $160 < v < 200$ km/h		
Span	Number of spans	
	≤ 2	≥ 3
≤ 25 m	$L/500$	$L/1000$
≥ 30 m	$L/800$	$L/1700$

Tab. 1. Deformations according to the German Standard DS 805

2. Classical calculus of the deflection

For a simple supported girder the value of the maximum deflection at midspan is

$$f = \frac{5}{48} \times \frac{M_{\max} \times l^2}{E \times I} \leq f_{\max} \tag{5}$$

EI – is the flexural rigidity of the beam

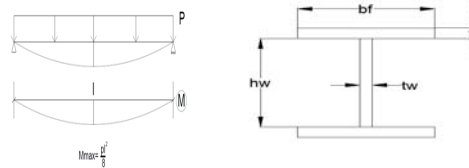

Fig.2 Analysed load cases

For a double symmetrical cross section with

$$M_{\max} = W \times R = \frac{I}{h} \times R$$

where R represents the design value of the resistance results:

$$f = \frac{5}{48} \times \frac{I}{h} \times 2R \times \frac{l^2}{E \times I} \leq f_{\max}$$

EI – is the flexural rigidity of the beam

$$f = \frac{5}{24} \times \frac{R \times l^2}{E \times h} \leq f_{\max} \quad (6)$$

$$f = k \times R \frac{l^2}{h} \quad \text{where} \quad k = \frac{5}{24E} \quad (7)$$

The necessary height of the girder results:

$$h_{nec} = \frac{5}{24} \times \frac{R}{E} \times \frac{l^2}{f_{\max}} \quad \text{and} \quad I_{nec} = \frac{5}{48} \times \frac{l}{f} \times \frac{1}{E} \times M_{\max} \times l \quad (8)$$

A first interesting conclusion: The deflection do not depend on the moment of inertia but only on the span l and the height of the beam. The designer can reduce deflections by increasing the depth of the element, reducing the span or providing greater restraints.

With the usual values $l/f = 500$ and a steel grade S235 with $R=235$ N/mm² results:

$$h_{nec} = \frac{5}{24} \times \frac{2350}{2100000} \times 500 \times l \approx \frac{l}{8,6} \quad (9)$$

For a steel grade S355 with $R=355$ N/mm² results:

$$h_{nec} = \frac{l}{5,7} \quad (10)$$

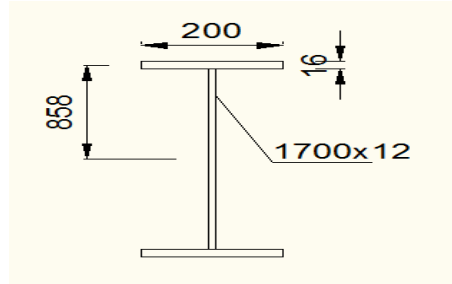
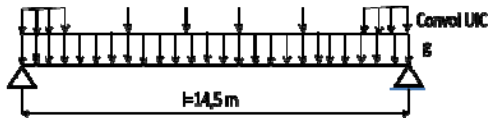

Fig. 3. Predimensioning a railway bridge

The deflection calculus and control assumes a particular significance with the development of the higher strength steels and the tendency to large spans in beams structures. For a simple supported girder with $l=13$ m, limiting the deflections results:

- for S235

$$h = \frac{13000}{8,6} \cong 1500$$

- for S355

$$h = \frac{13000}{5,7} \cong 2300$$

From equation (5) the value of the inertia moment for $f_{\max} = l/500$ is:

$$I_{nec} = \frac{5}{48} \times \frac{500}{2100000} \times M_{\max} \times l = 25 \times 10^6 \times M_{\max} \times l \quad [\text{cm}] \quad (11)$$

Relation (11) can be used for the initial determination of the cross section. If the cross section varies along the length of the beam (for example additional plates are provided), the deflection can be calculated by

$$f = \frac{P \times l^3}{48 \times EI} = \frac{M_{\max} \times l^2}{12 \times EI} = \frac{l}{h} \times 2R \times \frac{l^2}{12EI} = \frac{1}{6E} \times R \times \frac{l^2}{h}$$

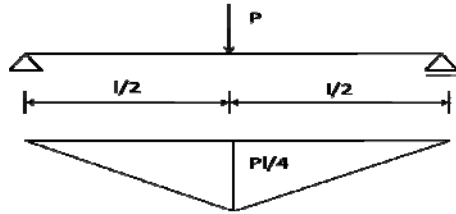
Fig.4 Load concentrated at $l/2$

The calculus above can be repeated also for others loadings. For a single load at midspan, results: (fig. 4)

As a general observation, these conditions are very severe. Often the steel beams have to be designed from the rigidity condition, that means that the maximum stresses in the structure are lower than the design value of the resistance.

In a similar way can be calculated the deflection for a continuous girder. More complicated is the situation in composite girders, where the construction sequence is essential.

3. Precambering necessity in steel plate girders

From the above considerations results the necessity of precambering. Deflections are counterbalanced by camber in beams. “Camber” (bent) comes from old French, respectively from Latin “camurum” (arched). Precamber is efficient even if the fabrication costs are higher. [3]

Generally for precambering (fcs) it is recommended [3]:

$$f_{cs} = f_g + \delta_{fu}$$

where

f_g – deflection produced by the permanent loads

δ_{fu} – deflection produced by live

loads

As a guide value, for δ , it can be taken 0,25 – 0,30 in Civil Engineering and 0,5 in bridges.

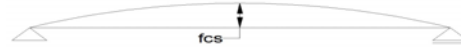

Fig.5 Precambering at steel plate girders

To induce a camber in a beam cold bending is the usual method and it involves brute force.

Hot bending is more labor intensive, time consuming and increasing the costs. The beam is heated in wedge-shape segments along the member at uniformly (not necessarily equally) spaced points, symmetric about the member centerline. A wedge is heated, the steel expands and bends the beam in a direction opposite to the intended camber (due to the longitudinal restraint of the cold steel around, which resists the expansion). Hot bending is used extensively in the repair of structural damaged elements. In modern steel shops, there are additional methods to induce camber [9].

Maximum camber is also limited in order to avoid serious over-stressing during the cambering operations (Recommendation – AISC Manual).

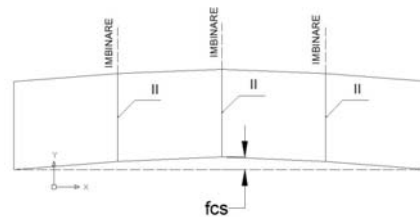
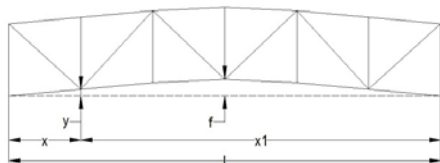

Fig.6 Maximum camber for welded plate steel girders

For welded plate steel girders the web will be composed by rhomboidal and not by rectangular elements. (Fig. 6)

In this situation the execution of the but welds requires a quality NDT control [10]. For truss girders, due to the height of the structure, the deflections are usually not important. Nevertheless, for crane girders and bridges a camber is recommended. The precambering has the parabola or a circle form (Fig. 7). In this situation the geometrical system of the girder is different.



$$y = 4xx_1 \frac{f}{l^2}$$

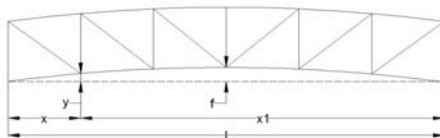

$$y = \sqrt{R^2 - x_1^2} - b \quad f = \frac{l^2}{8R} \quad b = R - f$$

Fig. 7. The precambering to the parabola or a circle form.

More complicated is the precambering problem by continuous girders especially for bridges, where different positions of the convoy have to be considered. In this case the precambering form is a S.

Case study

In the city of Oradea a private

company started the construction of a new bridge over the river “Crisul Repede”. The designer, an Italian design office, has chosen the solution of a continuous girder with variable height over three spans with the following sequence

$$L = 15,875 + 49,70 + 17,875 = 85 \text{ m}$$

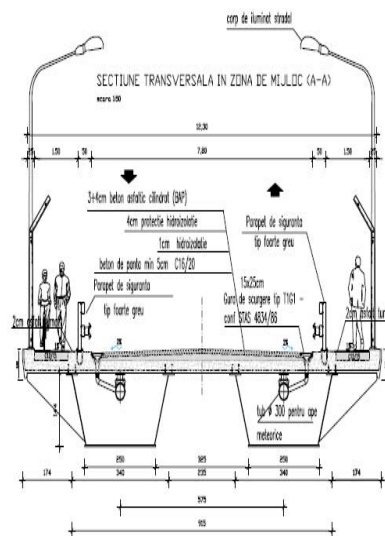

Fig.8. General view and cross section of the bridge.

It is a composite solution with two steel box girders and a deck composed of prefabricated slabs.

A first observation: the ratio between the central and the side spans is only 32% (outside of the usual recommendations), which has as result, the presence of ascending reaction forces in the end bearings on the abutments with following consequences:

complications in the design of abutment with the need of anchoring the structure and to provide a superior end bearing.

difficulties in the erection of the structure.

The height of girder is close to the recommended values of $L/25$ on the bearing and $L/40$ - $L/50$ in the middle of the span. The structure composed by a steel grade of S355K2W is over dimensioned (the actual stress are lower than the allowable ones) resulting an important self weight of approximately 2,5 tones/m for one girder. During the launching of the steel structure some rigidity problems appeared.

The structure is supported only on two piers, the abutments and the final bearings are not finished yet; in this situation the deformations are free without any restraint.

At the end a deflection of 81 mm and in the middle 69 mm were registered, which represents almost the half of the recommended value of $L/350=143$ mm (Fig.9).

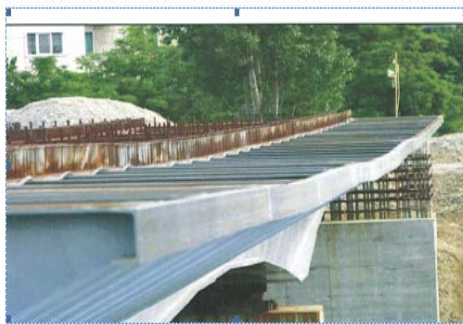

Fig.9 Deflection of bridge structure

In the situation if the concrete slabs – aprox 3,75 tones/m, are disposed on the steel structure, the final deflection will have a value of ≈ 100 mm, which is visible, having an unaesthetic aspect and consuming 75% of the

recommended value of the maximal deflection.

This example underlines the importance of the initial preambering avoiding many problems.

For continuous girders bridges the preambering problem is more complicated. In this situation the deflections are positive (sagging) or negative (hogging) depending on the position of the convoy. A possible solution is the superposition of the resulted deflections from the successive positions of the convoy.

A case study was performed on a continuous plate girder railway bridge, having the following spans: $L=30+40+30$ m, loaded by the dead load and the UIC-71 convoy according to EC1-2 (Fig.10).

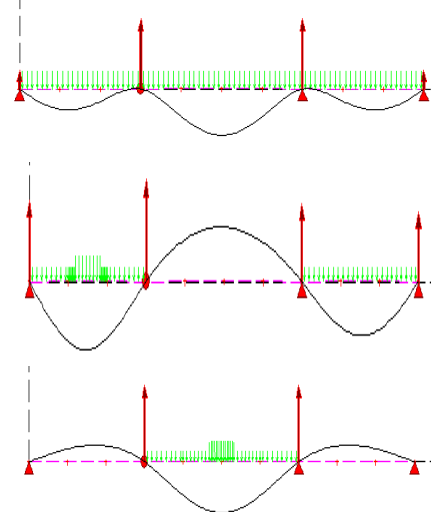

Fig.10. Railway bridge load

The deflections in an interval of 10 m from the dead load f_{g0} , and the UIC-71 convoy in the most unfavorable position in the marginal f_{cm} and the central field f_{cc} were determined. (fig.11)

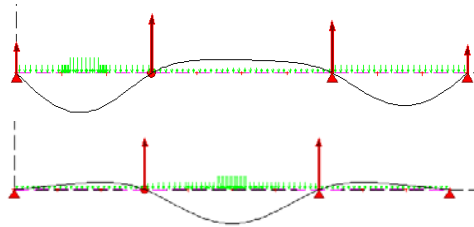

Fig.11 UIC-71 convoy in the most unfavorable position in the marginal and in the central field

Taking into account that the deflections are positive and negative, a combined value f_c are resulting from the superposition of f_{cm} and f_{cc} .

In the next step a precambering was applied with the following value: $(f_{g0} + \alpha f_{c,cum})$. With $\alpha=0,2; 0,3;0,4;0,5;0,6;0,7;0,8;0,9;1$ eight cases (A-H) were analyzed: Table 2.

Tabelul 2

X= (m)	FUIC				contrasageata				sageata finala din G				sageti finale pe ipoteze de incarcare							
	f_{G0}	f_{cm}	f_{cc}	f_{Ccum} (cm+cc)	f_{cs-A} $f_{g+0.2u}$	f_{cs-B} $f_{g+0.3u}$	f_{cs-C} $f_{g+0.4u}$	f_{cs-D} $f_{g+0.5u}$	f_{g-A}	f_{g-B}	f_{g-C}	f_{g-D}	L_{cm-A}	L_{cc-A}	L_{cm-B}	L_{cc-B}	L_{cm-C}	L_{cc-C}	L_{cm-D}	L_{cc-D}
0	0	0	0	0	0	0	0	0	0	0	0	0	0	0	0	0	0	0	0	0
10	-5.7	-33.9	8.4	-25.5	11	13	16	18	5	8	10	13	-29	14	-26	16	-24	19	-21	21
20	-3.5	-29.9	14.2	-15.7	7	8	10	11	3	5	6	8	-27	17	-25	19	-24	20	-22	22
30	0	0	0	0	0	0	0	0	0	0	0	0	0	0	0	0	0	0	0	0
40	-7.7	11.9	-45.5	-33.6	14	18	21	25	7	10	13	17	19	-39	22	-35	25	-32	29	-29
50	-12.9	12.3	-70	-57.7	24	30	36	42	12	17	23	29	24	-58	30	-53	35	-47	41	-41
60	-7.7	10.5	-45.5	-35	15	18	22	25	7	11	14	18	18	-39	21	-35	25	-32	28	-28
70	0	0	0	0	0	0	0	0	0	0	0	0	0	0	0	0	0	0	0	0
80	-3.5	-24.9	14.2	-10.7	6	7	8	9	2	3	4	5	-23	16	-22	17	-21	18	-20	20
90	-5.7	-19.8	8.4	-11.4	8	9	10	11	2	3	5	6	-18	11	-16	12	-15	13	-14	14
100	0	0	0	0	0	0	0	0	0	0	0	0	0	0	0	0	0	0	0	0

X= (m)	FUIC				contrasageata				sageata finala din G				sageti finale pe ipoteze de incarcare							
	f_{G0}	f_{cm}	f_{cc}	f_{Ccum} (cm+cc)	f_{cs-E} $f_{g+0.6u}$	f_{cs-F} $f_{g+0.7u}$	f_{cs-G} $f_{g+0.8u}$	f_{cs-H} f_{g+u}	f_{g-E}	f_{g-F}	f_{g-G}	f_{g-H}	L_{cm-E}	L_{cc-E}	L_{cm-F}	L_{cc-F}	L_{cm-G}	L_{cc-G}	L_{cm-H}	L_{cc-H}
0	0	0	0	0	0	0	0	0	0	0	0	0	0	0	0	0	0	0	0	0
10	-5.7	-33.9	8.4	-25.5	21	24	26	31	15	18	20	26	-19	24	-16	26	-14	29	-8	34
20	-3.5	-29.9	14.2	-15.7	13	14	16	19	9	11	13	16	-20	24	-19	25	-17	27	-14	30
30	0	0	0	0	0	0	0	0	0	0	0	0	0	0	0	0	0	0	0	0
40	-7.7	11.9	-45.5	-33.6	28	31	35	41	20	24	27	34	32	-25	35	-22	39	-19	46	-12
50	-12.9	12.3	-70	-57.7	48	53	59	71	35	40	46	58	47	-35	53	-30	58	-24	70	-12
60	-7.7	10.5	-45.5	-35	29	32	36	43	21	25	28	35	32	-25	35	-21	39	-18	46	-11
70	0	0	0	0	0	0	0	0	0	0	0	0	0	0	0	0	0	0	0	0
80	-3.5	-24.9	14.2	-10.7	10	11	12	14	6	7	9	11	-18	21	-17	22	-16	23	-14	25
90	-5.7	-19.8	8.4	-11.4	13	14	15	17	7	8	9	11	-13	15	-12	16	-11	18	-8	20
100	0	0	0	0	0	0	0	0	0	0	0	0	0	0	0	0	0	0	0	0

In figure 12(precambering and the final deflections), the calculated values are represented.

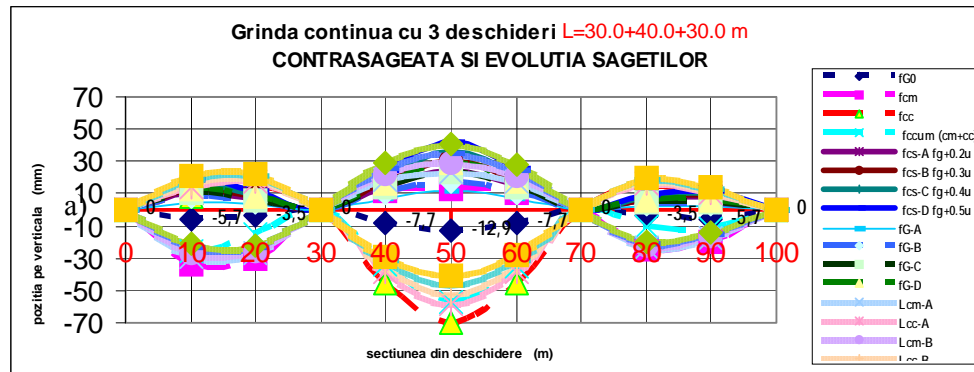



Figura 12. Precambering and the final deflections: a) situation A-D ; b) situation E-H

In table 3, the allowable values for deflections in different situation are given.

Tabelul 3

L=	sagetii admisibile la rapoarte L/n [cm]					
(m)	350	500	1000	1200	1500	2000
40	11.4	8	4	3.33	2.66	2
30	8.57	6	3	2.5	2	1.5

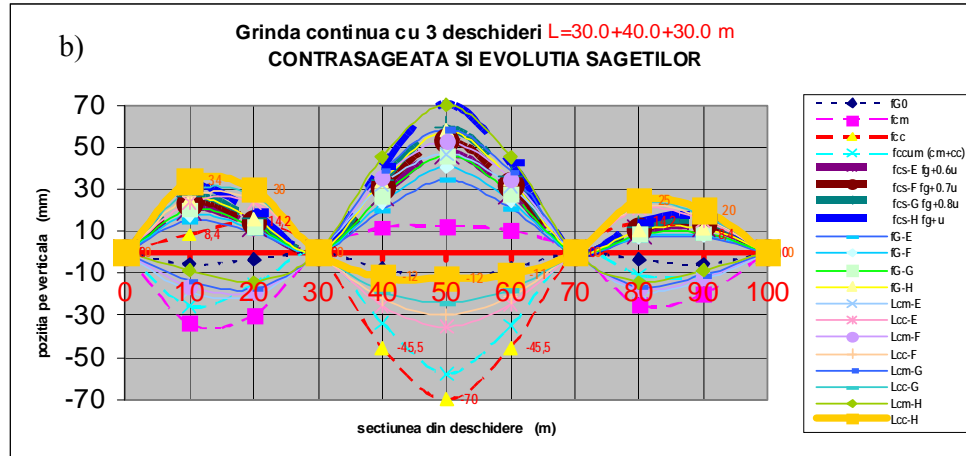
In conclusion, the proposal is to apply a preambering of $(f_{g0}+0,5f_{c,cum})$ and to make a final verification of the structure loaded by the dead load and convoy.

Conclusion: Precambering is always necessary in plate girders and especially in plate girder bridges. Even if the fabrication is more complicated (there are different technologies in this direction), preambering must be introduced in the initial design of the structure.

References

1. Ch. J. Carter, "Serviceability Design Considerations for Steel Buildings", Modern Steel Construction, November 2004;
2. *** EN 1990:2012+A1 (December 2005) "Eurocode – Basis of Structural Design";
3. Christian Petersen, "Stahlbau" 4. Auflage, Springer Verlag 2013, ISBN 987-3-528-38837-9;
4. Christoph Sesselberg, "Kranbahnen", Bauwerk Verlag 2009, ISBN 987-3-89932-218-7;
5. *** SR EN 1993-6 "Proiectarea structurilor de oțel – Căi de rulare", ASRO – iulie 2008;

6. *** SR EN 1990:2004/A1:2006 “Bazele proiectării structurilor”, ASRO – decembrie 2006;
7. *** “Vorschrift für Eisenbahnbrücken und sonstige Ingenieurbauwerke” DS-804, Deutsche Bundesbahn;
8. Edward Petzek, Radu Băncilă, “Alcătuirea și calculul podurilor cu grinzi metalice înglobate în beton”, Editura Orizonturi Universitare, Timispara, 2006, ISBN (10) 973-638-283-4
9. B. Bresler, T. Lin, J. Scalzi, “Design of Steel Structures”, John Wiley, 1968, Catalogue Card Number 67-29012;
10. *** SR EN 1090 “Execuția structurilor de oțel și structurilor de aluminiu”