



## MODELING A CAR BUMPER MADE FROM NEW COMPOSITE MATERIALS

<sup>1</sup>Adrian Calieniug, <sup>2</sup> Gheorghe N. Radu  
<sup>1,2</sup>Transilvania University of Brasov, Romania

*Abstract* - In this paper, the concept of the new composite materials used in car bumpers construction for automotive industry is a real interest in safety factor of the first passenger car and its structure. Time is a key factor in finding materials and composite structures with high resistance such as that presented a series of composite materials that make up the sandwich structure of the bumper. Composition, resistance to bending and hauling, recycling of new structure composites make them ideal for the production of new types of vehicle bumpers.

*Keywords* - bumpers, car, bending, composites, recycling

### 1. INTRODUCTION

One of the main issues is the safety of a vehicle that offers to passengers and the first component is affected in a frontal impact or rear bumper. This is to reduce vehicle damage and reduce the drag caused by the dynamic resistance of the air. Air is a direct impact on a vehicle, therefore, sports cars have a very efficient design bumpers construction which is provided in very large air intakes. It also plays an important role in this aspect of the custom car builder in each hand. International law required that all vehicle manufacturers have provided in the construction of car bumpers front and rear.



Figure. 1. Front bumper

By using composite materials bumper structure will lead to a weight loss of vehicle weight, lower fuel consumption and pollutant emissions of greenhouse gases, and high resistance to impact and corrosion.

### 2. EXPERIMENTAL AND NUMERICAL METHODS

In this experiment were used as epoxy resin hardener fiberglass reinforcing fabric, nylon 6 / 10 and ABS.

Stage I which consists of a sequence of different materials that make up a composite plate;

Stage II consisted of cutting specimens in 100mm length, width 10mm and 5mm thick;

Stage III testing specimens in bending test machine;

Stage IV obtaining results from the bending machine;

Stage V interpretation of results from bend testing machine and obtaining data using Matlab program as graphs that were force-displacement coordinates;

STAGE I- composition of many materials and form a plate-shaped composite structures:



**Figure. 2.** Composite board structure consisting of epoxy resin with hardener and reinforcement of 6 layers of fiberglass fabric



**Figure. 3.** Composite board structure consisting of epoxy resin with hardener and 2 layers of fabric reinforced nylon 6 / 10

STAGE II - consisted of cutting specimens in 100mm length, width 10mm and 5mm thick;



**Figure. 4.** Cutting specimens in 100mm length, width 10mm and 5mm thick.



**Figure. 5.** Specimen viewed from the side with the 6 layers of fiberglass fabric  $280\text{g/m}^2$  thickness , [1]



**Figure. 6.** Sandwich structure consists of two test-piece fiberglass reinforced with ABS, [1]

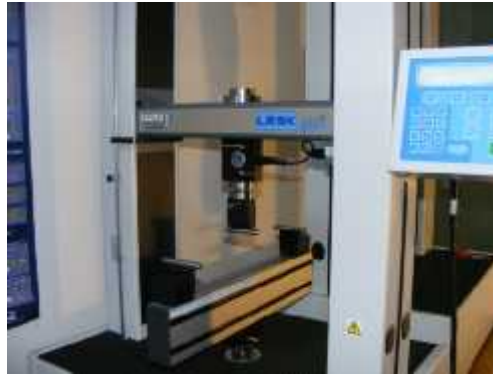


**Figure. 7.** Sandwich structure reinforced with fiberglass, [2]



**Figure. 8.** Sandwich structure consists of two test-piece fiberglass reinforced with ABS and nylon 6/10

STAGE - III consisted of placing specimens in bend testing machine;



**Figure .9.** Bend testing machine in 3 points

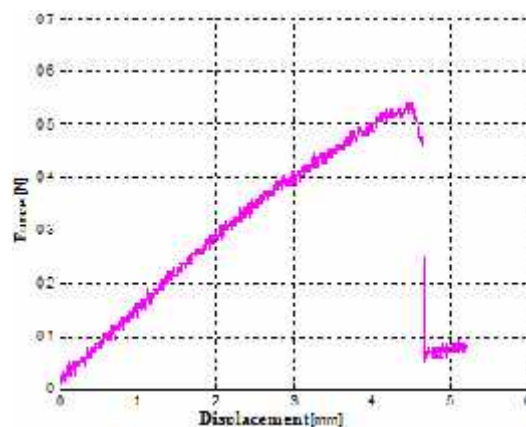
For three-point bending attempt to use a car type LR5K Plus. But which provides maximum strength of  $F_{max} = 5 \text{ kN}$  .

STAGE IV obtaining results from the bending machine;

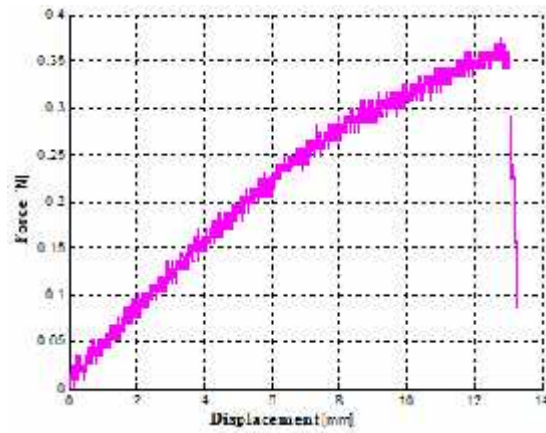


**Figure .10.** Bend testing a fiberglass specimen

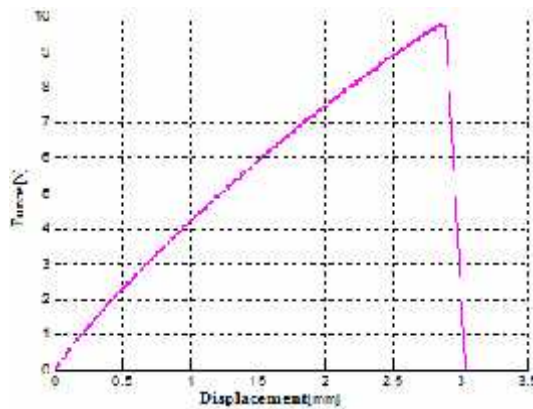
STAGE V - interpretation of results from bend testing machine and obtaining data using Matlab program as graphs that were force-displacement coordinates;



**Figure. 11.** The bending results for the material reinforced composite ABS



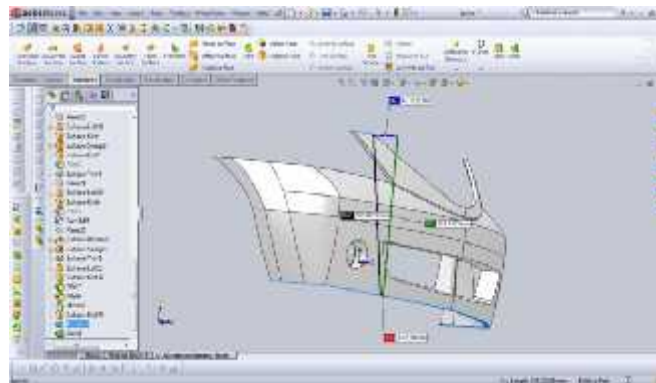
**Figure. 12.** The bending results for the material reinforced composite fiberglass fabric, [2]



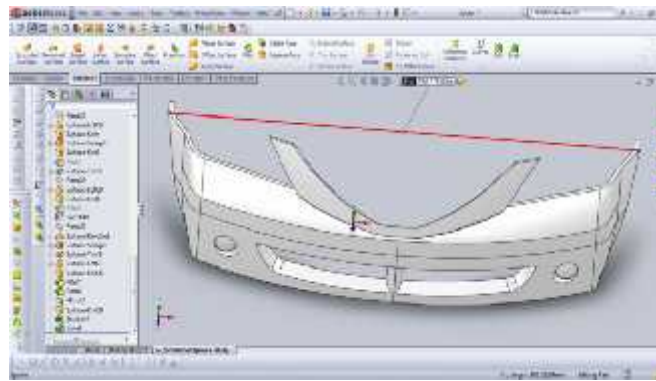
**Figure. 13.** The bending results for the material reinforced composite with nylon 6/10

From measurements made on a para-shock front bar for the type of car brand Dacia Logan were used SolidWorks design software in order to obtain a series of para-shock bumpers using several types of materials: ABS, epoxy resin fabric reinforced with fiberglass and nylon 6 / 10.

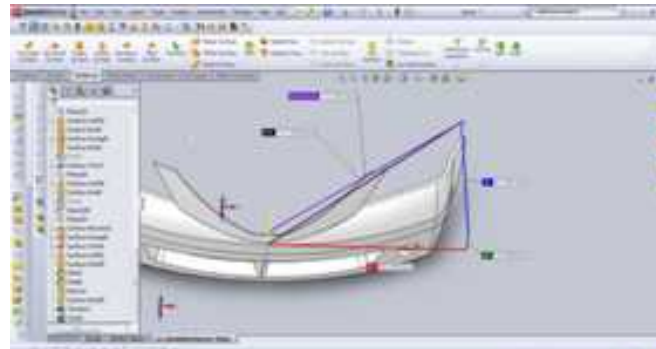
Here are some steps Solidworks modeling using the para-shock front bumper of the car:



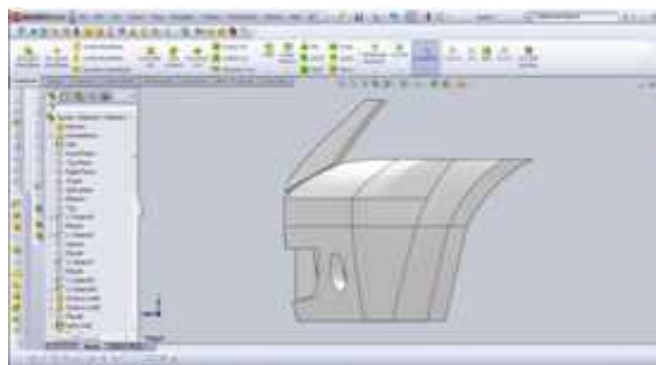
**Figure. 14.** Bumper height is assigned



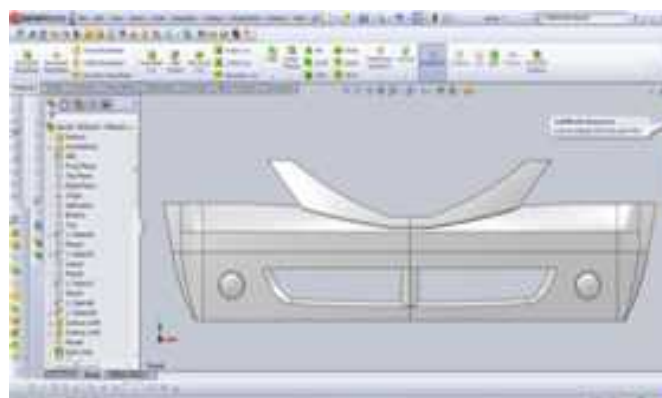
**Figure.15.** Bumper car width is sized



**Figure.16** Is assigned the angles and thickness of the bumper



**Figure. 17.** Bumper car viewed from the side



**Figure. 18.** Actual modeling of the bumper car

Modeling is for the 3 types of materials used in the experiment: ABS, glass fiber fabric and epoxy resin fiberglass fabric reinforced Nylon 6 / 10.

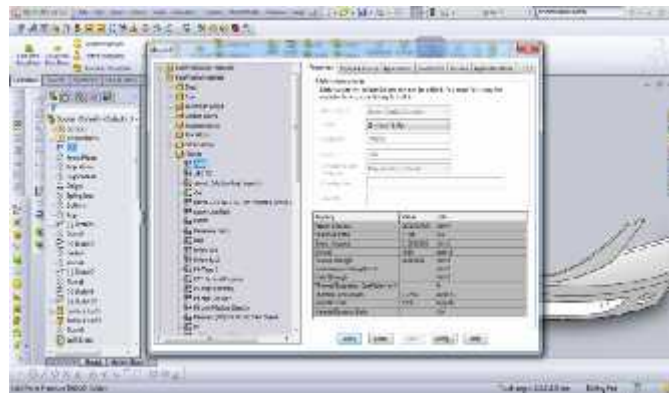


Figure.19. Material characteristics

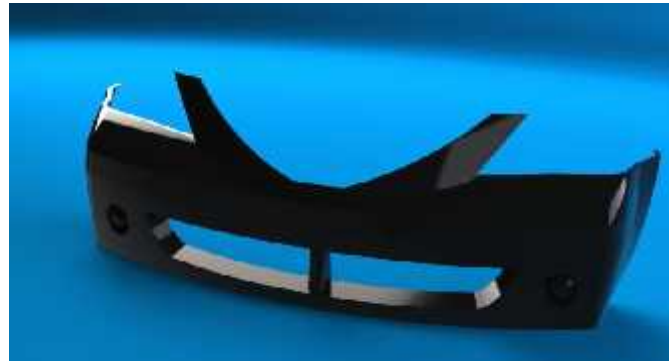


Figure. 20. The material used for lining:  
ABS

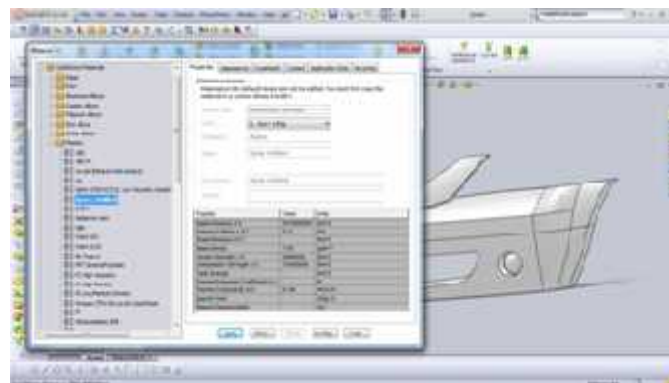


Figure. 21. Material characteristics

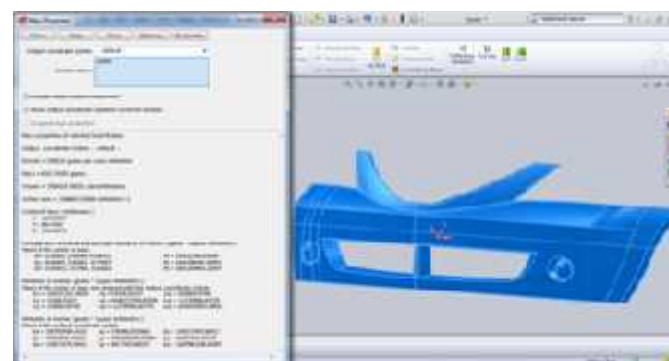
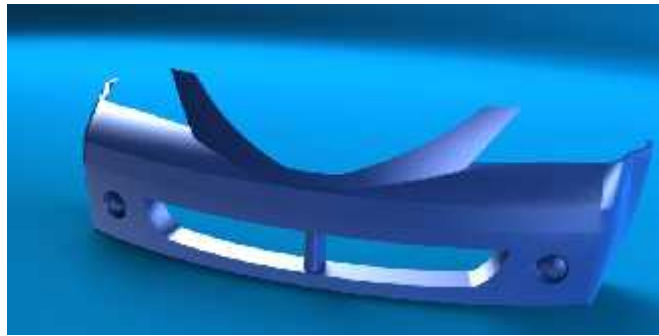
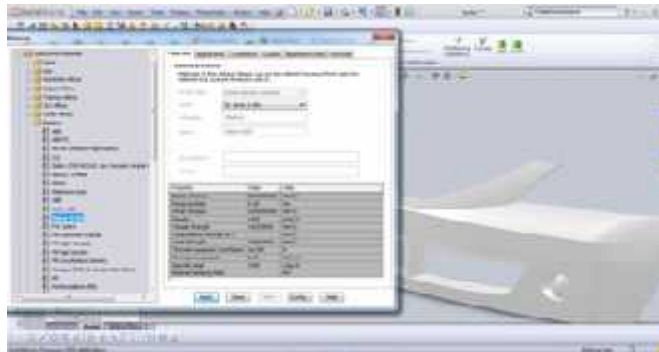


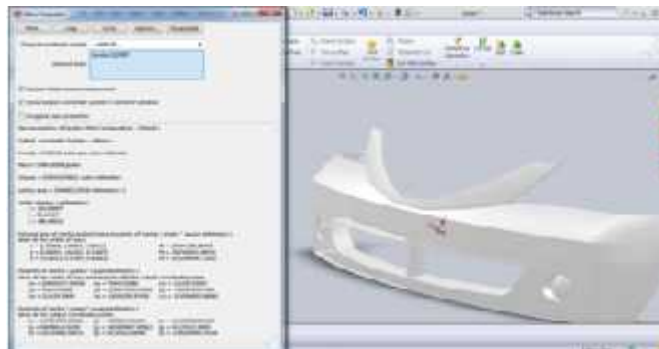
Figure. 22. Material specifications



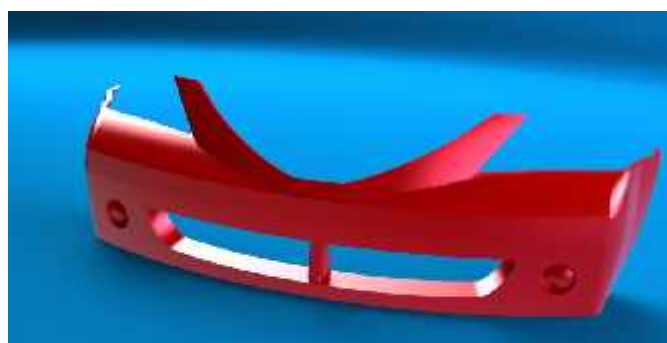
**Figure. 23.** The material used for lining:  
Fiberglass fabric with epoxy resin



**Figure. 24.** Material characteristics



**Figure. 25.** Material specifications



**Figure. 26.** The material used for lining: Nylon 6/10

### 3. CONCLUSIONS

After studying the model and developing some empirical research with the equipments and software programs mentioned the following conclusive ideas may be presented:

1. Study on new composite materials showed that the composite material of glass fiber reinforced nylon has a breaking strength greater than the other two materials were tested and the charts confirm that.
2. Modeling a car bumper was made taking into account the type of material used for bend testing.
3. Research will come in to the finite element analysis, impact analysis and will be pursued based on this study.

## **ACKNOWLEDGEMENT**

This papers supported by the Sectorial Operational Programme Human Resources Development (SOP HRD), financed from the European Social Fund and by the Romanian Government under the contract number POSDRU/88/1.5/S/59321

## **REFERENCES**

- [1] Calieniug, A., Radu, N. Gh., Theoretical and Experimental Studies Based on Composite Materials Reinforced with E-Glass Fiber Made of Nylon or Silicone, Proceedings of AI XVI-lea Simpozion National de Mecanica Ruperii, Ploiesti, Romania, 2010, p. 37-38.
- [2] Calieniug, A., Radu, N. Gh., Theoretical and Experimental Studies on Composite Materials Reinforced with Polystyrene or Nylon Fibers, Proceedings of 15<sup>th</sup> International Conference Modtech2011,ISSN 2069-6736 , Vadul lui Voda-Chisinou, Moldova, 2010.